

**Uniden®**

**SS E15**

**Series Owner's Manual**

**OWNER'S MANUAL**



# Contents

<b>Welcome/Features</b>	<b>2</b>	<b>Emergency Dial</b>	
<b>Controls and Functions</b>	<b>3</b>	Emergency Dial	20
<b>Terms Used in this Manual</b>	<b>4</b>	Storing the Emergency Dial	20
<b>Getting Started</b>		<b>Using the Speed Dial Memory</b>	
Installing the Phone	5	Using the Speed Dial Memory	21
A. Choose the Best Location	5	Storing Names and Numbers in	
B. Connect the Base Unit and Charge		Speed Dial Memory	21
the Handset	6	Storing Caller ID Messages	
C. Set the Visual Ringer Brightness	8	in Speed Memory Locations	24
D. Mount the Base Unit on a Wall	9	Making Calls from Speed Dial Memory	25
Installing the Belt Clip	10	Easy Dial	25
Headset Installation	10	<b>Caller ID Features</b>	
Basic Setup	11	Caller ID and CIDCW (Caller ID on Call Waiting)	26
Auto Talk	11	When the Telephone Rings	26
Activating Caller ID on Call Waiting	11	Viewing the Caller ID Message List	27
Name Tag (POP ID)	12	Deleting Information from the Caller ID List	28
Insert 0	13	Making a Call from the Caller ID List	30
Selecting the Ringer Tone and Volume	14	<b>Additional Information</b>	
<b>Basics</b>		Changing the Digital Security Code	31
Using Your Phone	15	Note on Power Sources	32
Making and Receiving Calls	15	Installing a Replacement Battery	33
Adjusting the Handset Earpiece Volume	16	Maintenance	34
Traveling Out-of-Range	17	Troubleshooting	35
Selecting a Different Channel	18	Liquid Damage	37
Find Handset	18	General Information	38
Using Call Waiting	19	Index	39
Visual Message Waiting Indicator	19	Warranty	40



# Welcome

# Features

Congratulations on your purchase of the Uniden cordless telephone. This cordless phone is designed and engineered to exacting standards for reliability, long life, and outstanding performance.

**Note: Some illustrations in this manual may differ from the actual unit for explanation purposes.**

- 2.4GHz Extended Range Technology
- Visual Ringer LED
- Large Backlit Keys
- Caller ID\*
  - Caller ID on Call Waiting\* (CIDCW)
  - Name Tag\* (POP ID)
- 10 Speed Dial Memory
- One-Touch Emergency Dial
- 3 Line Backlit Easy to Read Display
- Audio Boost
- Last Number Redial
- Find Handset Key
- Earpiece/Ringer Volume Controls
- Hearing Aid Compatible
- 20 Channel Auto Scan
- Desk or Wall Mountable

\* The Caller ID and Caller ID on Call Waiting features require subscription to the services provided by your network supplier. There is usually a fee for these services. The Caller ID on Call Waiting service is currently unavailable in New Zealand.

**Be sure to visit our Website: [www.uniden.com.au](http://www.uniden.com.au) or [www.uniden.co.nz](http://www.uniden.co.nz)**

# Controls and Functions

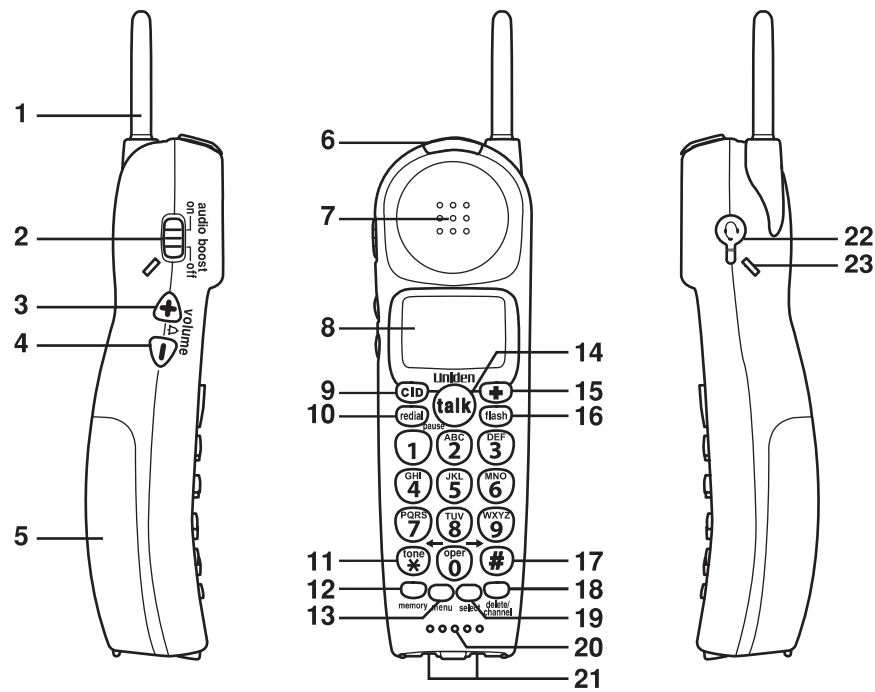

1. Handset antenna
2. Audio boost switch
3. **Volume/  $\Delta$  (ring)/+** key (p. 16/ 14)
4. **Volume/  $\Delta$  (ring)/-** key (p. 16/ 14)
5. Handset battery compartment
6. Handset visual ringer LED
7. Handset earpiece
8. LCD display
9. **CID** key (p. 27)
10. **Redial/pause** key (p. 16/ 23)
11. **X /tone/  $\leftarrow$**  key (p. 22)
12. **Memory** key (p. 21)
13. **Menu** key (p. 11)
14. **Talk** key (p. 15)
15. **Emergency** (**+**) key (p. 20)
16. **Flash** key (p. 19)
17. **# /  $\rightarrow$**  key (p. 22)
18. **Delete/channel** key (p. 22/ 18)
19. **Select** key (p. 11)
20. Handset microphone and ringer speaker
21. Handset charging contacts
22. Headset jack
23. Beltclip hole

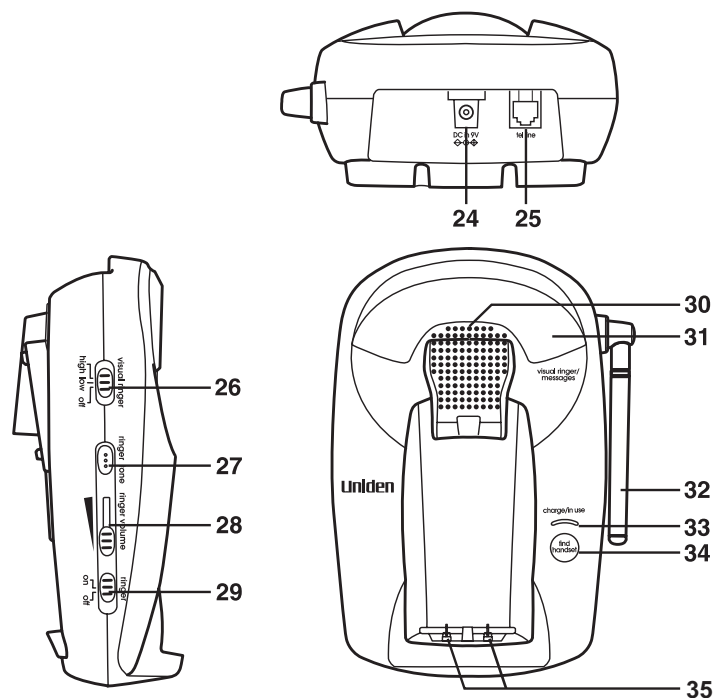

- 24. DC in 9V jack
- 25. Telephone line jack
- 26. Visual ringer switch (p. 8)
- 27. Ringer tone button (p. 14)
- 28. Ringer volume adjuster (p. 14)
- 29. Ringer on/off switch (p. 14)
- 30. Base speaker
- 31. Base visual ringer LED
- 32. Base antenna
- 33. Charge/in use LED (p. 6)
- 34. Find handset key (p. 18)
- 35. Base charging contacts

### Terms Used in this Manual

- Standby Mode - The handset may be sitting in or off the base, but is NOT in use. The **talk** key has not been pressed and there is no dial tone.
- Talk Mode - The handset is off the base and the **talk** key has been pressed, enabling a dial tone.
- CID - Caller ID
- CIDCW - Caller ID on Call Waiting
- Emergency Dial - One touch speed dial key





# Installing the Phone

## Do the following steps:

- A. Choose the best location
- B. Connect the base unit and charge the handset
- C. Set the visual ringer brightness (optional)
- D. Mount the base unit on a wall (optional)

## A. Choose the best location

When choosing a location for your new phone, here are some important guidelines you should consider:

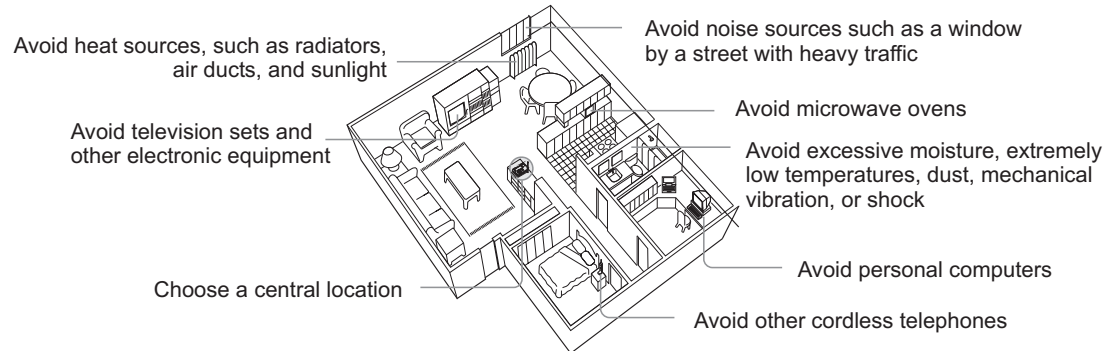

- The location should be close to both a phone jack and a continuous power outlet (one which is not connected to a switch).
- The base and handset should be kept away from sources of electrical noise such as motors and fluorescent lighting.
- The base can be placed on a desk, tabletop, or mounted on a standard wall plate. For better reception, place the base as high as possible.
- The base should be placed in an open area for optimum range and reception.



- If your home has specially wired alarm equipment connected to the telephone line, be sure that installing the system does not disable your alarm equipment.
- If you have questions about what will disable your alarm equipment, contact your telephone company or a qualified installer.





- Use only the supplied AAD--041S AC adapter. Do not use any other AC adapter.

- Do not place the power cord where it creates a trip hazard or where it could become chafed and create a fire or electrical hazard.

## B. Connect the Base Unit and Charge the Handset

- 1) Connect the AC adapter to the **DC in 9V** jack and to a standard 240V AC wall outlet.



- Connect the AC adapter to a continuous power supply.
- Place the base unit close to the AC outlet so that you can unplug the AC adapter easily.

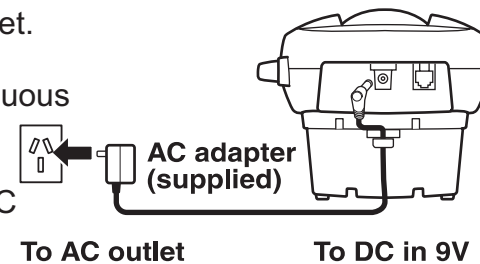

**The rechargeable battery is already installed in your phone.**

- 2) Place the handset in the base unit.
- 3) Make sure that the **charge/in use** LED illuminates. If the LED does not illuminate, check to see that the AC adapter is plugged in and the handset makes good contact with the base charging contacts.
- 4) **Charge the handset battery pack for at least 15-20 hours before using your new cordless telephone for the first time!** To maximize the charge capacity of your battery pack, DO NOT plug the telephone cord into the base unit and wall jack until the battery is fully charged.

- 5) Once the handset battery pack is fully charged, connect the telephone line cord to the **tel line** jack and to a telephone outlet. If your telephone outlet isn't modular, contact your telephone company for assistance.

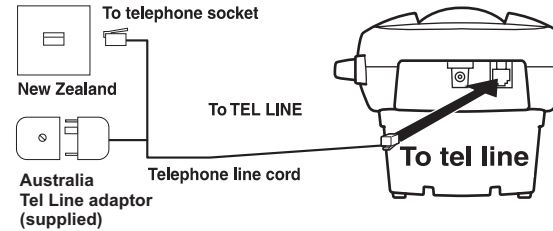

- 6) After the phone is connected, pick up the handset from the base and press **talk**. If you do not get a dial tone, check the following:
- Be sure the telephone cord is securely connected to both the base and an active telephone jack.
  - Be sure the **charge/in use** LED is on. If not, check the AC adapter.
  - Be sure the handset is fully charged.
  - Be sure the battery is installed correctly.

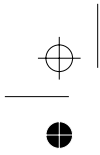

### C. Set the Visual Ringer Brightness

The **visual ringer** switch allows you to set the brightness of the **visual ringer/messages** LED on the base. There are three options to choose from: high, low and off. If you set the switch to off, **visual ringer/messages** LED never flashes.

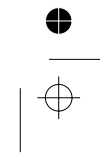
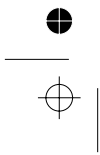
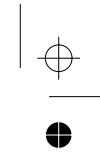
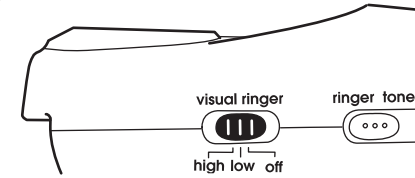



## D. Mount the Base Unit on a Wall

### Standard wall plate mounting

This phone can be mounted on any standard 1 wall plate.

- 1) Remove the wall mount adapter from the base and snap it into the notches on the bottom of the base.
- 2) Plug the AC adapter to the **DC in 9V** jack.
- 3) Wrap the AC adapter cord inside the molded wiring channel as shown.
- 4) Plug the AC adapter into a standard 240V AC wall outlet.
- 5) Plug the telephone line cord into the **tel line** jack.
- 6) Wrap the cord inside the molded wiring channel as shown.
- 7) Plug the telephone line cord into the telephone outlet.
- 8) Raise the antenna to a vertical position.
- 9) Align the mounting slots on the base with the mounting posts on the wall.  
Then push in and down until the phone is firmly seated.

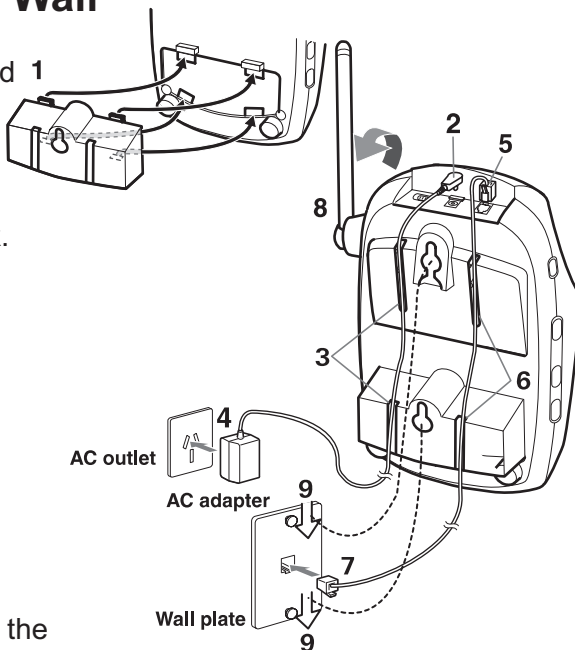

If the base unit is mounted on the wall, always put the handset in the base with the CID display facing forward to make sure the handset does not fall out of the base.

### Direct wall mounting

If you don't have a standard wall plate, you can mount your phone directly to the wall. Before doing this, consider the following:

- Avoid electrical cables, pipes, or other items behind the mounting location that could cause a hazard when inserting screws into the wall.

[9]



GETTING STARTED



- Try to mount your phone within 1.5m of a working phone jack to avoid excessive cord lengths.
- Make sure the wall material is capable of supporting the weight of the base and handset.
- Use #10 screws (minimum length of 35mm) with anchoring devices suitable for the wall material where the base unit will be placed.

- 1) Insert two mounting screws into the wall, (with their appropriate anchoring device), 100mm apart. Allow about 3mm between the wall and screw heads for mounting the phone.
- 2) Refer to steps 1 through 9 on page 9 to mount the telephone.

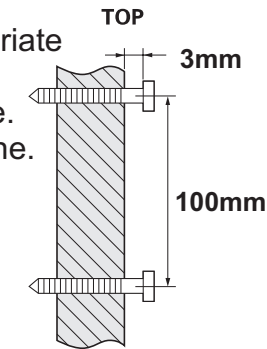

## Installing the Beltclip

### To attach the beltclip

Insert the beltclip into the holes on each side of the handset. Press down until it clicks.

### To remove the beltclip

Pull both sides of the beltclip to release the tabs from the holes.

## Headset Installation

Your phone may be used with an optional headset.

To use this feature, insert the headset plug into the headset jack.

Your phone is ready for hands-free conversations.

(Headset may be purchased by visiting our website at; [www.uniden.com.au](http://www.uniden.com.au) or [www.uniden.co.nz](http://www.uniden.co.nz) )





## Basic Setup

There are four basic options that you will need to set up: AutoTalk, CIDCW (Caller ID on Call Waiting), Name Tag and Insert 0.

### AutoTalk

Autotalk allows you to answer the phone simply by removing the handset from the base. You do not have to press any keys.

- 1) When the phone is in standby mode, press the **menu** key. The following screen appears.
- 2) Press the **select** key to turn AutoTalk on.
- 3) Press the **menu** key to complete the setting. The handset returns to standby mode.

```
▶ Auto Talk   :On
  CIDCW      :Off
  Name Tag    :On
```

### Activating Caller ID on Call Waiting

Caller ID allows you to see the number of the calling party before you answer the phone. Caller ID on Call Waiting (CIDCW) lets you see the number of a call that comes in when you are on the line.

You must subscribe to Caller ID service through your local telephone provider to use this feature. You must also subscribe to Call Waiting Service to use Caller ID on Call Waiting.

- 1) When the phone is in standby mode, press the **menu** key. The following screen appears.

```
▶ Auto Talk   :On
  CIDCW      :Off
  Name Tag    :On
```



- 2) Press the **volume/**  $\Delta$  **/-** key to select CIDCW.
- 3) Press the **select** key to toggle and turn on Caller ID on Call Waiting.
- 4) Press the **menu** key and **return the handset to the base unit** to complete the setting. The handset returns to standby mode.

### Setting Name Tag (POP ID)

The Name Tag feature works with the Caller Display number from Caller ID. You must subscribe to Caller ID service through your local telephone provider to use this feature. There is usually a fee for this service. When the phone rings the caller display number, when received will be compared to numbers stored in the dial memory. If there is a match then any name stored with the dial memory number will be displayed (see page 21).

- 1) When the phone is in standby mode, press the **menu** key. The following screen appears.

```

┌ Auto Talk   :On
├ CIDCW      :Off
└ Name Tag   :On

```

- 2) Press the **volume/**  $\Delta$  **/-** key twice to select Name Tag .

```

┌ Auto Talk   :On
├ CIDCW      :Off
└ Name Tag   :On

```

- 3) Press the **select** key to toggle Name Tag On or Off.
- 4) Press the **menu** key to complete the setting. The handset returns to standby mode.



## Setting the Insert 0

This feature adds '0' or '00' to the number, when you receive Caller ID messages. The default setting for New Zealand is On. The default setting for Australia is Off.

- 1) When the phone is in standby mode, press the **menu** key. The following screen appears.

```
▶ Auto Talk :On  
CIDCW      :Off  
Name Tas   :On
```

- 2) Press the **volume/**  **/-** key three times to select Insert 0.

```
CIDCW      :Off  
Name Tas   :On  
▶ Insert 0  :Off
```

- 3) Press the **select** key to toggle Insert 0 On or Off.
- 4) Press the **menu** key to complete the setting. The handset returns to standby mode.



## Selecting the Ringer Tone and Volume

### Base ringer on/off

The **ringer on/off** switch allows you to set the base ringer on or off. If you set the switch to off, you never hear the base ringer tone.



### Base ringer tone

Press the **ringer tone** button in standby mode to select one of 7 ringer tones.

### Base ringer volume

Slide the **ringer volume** adjuster to set the base ringer volume.

### Handset ringer tone and volume

Press the volume up key or volume down key (labeled as the **volume/**  $\Delta$  **/+** or **volume/**  $\Delta$  **/-** key) in standby mode to select one of five ringer tones and volume combinations.



# Using Your Phone

## Making and Receiving Calls

### Making a call

- 1) Remove the handset from the base.
- 2) Press the **talk** key.
- 3) Listen for the dial tone.
- 4) Dial the number.

OR

- 1) Remove the handset from the base.
- 2) Dial the number.
- 3) Press the **talk** key.

### Receiving a call

- 1) Remove the handset from the base (If AutoTalk is on, the phone will automatically answer the call when you pick it up).
- 2) If the handset is off the base, press the talk key (or any number key, \*/tone/← key or #/→ key if AutoTalk is on).

### Hanging up

Press the **talk** key or return the handset to the base.

[15]



Refer to page 11  
"Basic Setup" to  
turn On the  
AutoTalk feature  
if desired.



BASICS

## Redialing the last dialed number

- 1) Remove the handset from the base.
- 2) Press the **talk** key.
- 3) Listen for the dial tone.
- 4) Press the **redial/pause** key.

OR

- 1) Remove the handset from the base.
- 2) Press the **redial/pause** key.
- 3) Press the **talk** key.

## Adjusting the Handset Earpiece Volume

To change the earpiece volume, press **volume/**  $\Delta$  **/+** or **volume/**  $\Delta$  **/-** key during a call.

### Audio boost

As we get older, it often becomes harder to hear high frequency tones. Audio Boost lets you hear phone conversations more clearly by boosting the high frequency tones.

To set Audio boost on, slide the **audio boost** switch upward.  
**Boost On** appears on the display under the volume setting when you start a call.

To set Audio boost off, slide the **audio boost** switch downward.

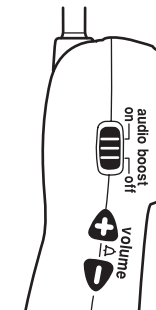

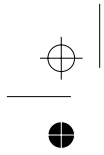

## Traveling Out-of-Range

During a call, as you begin to move your handset too far from your base unit, noise increases. If you pass the range limits of the base unit, your call will terminate within 1 minute.

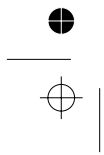

[17]





The **UltraClear Plus** true compander circuitry virtually eliminates background noise. This innovative technology, together with 20 different channels, provides you with the best possible reception during all your conversations.

## Selecting a Different Channel

If you encounter interference while using your phone, you can manually change the phone's channel for clear operation. This function works only when the phone is in use. Press the **delete/channel** key. **Scanning** appears on the display, indicating the phone is changing to another channel.

## Find Handset

If you lost the handset, press the **find handset** key on the base. The **visual ringer** LED on the handset flashes, and the handset beeps for 60 seconds. Paging is canceled when pressing any handset key, the **find handset** key on the base or the handset is returned to the base. Paging is also canceled when the phone receives an incoming call.





## Using Call Waiting

If you have Call Waiting service, you can receive calls while on the line.

- 1) If a call comes in while you are on the phone, you will hear a call waiting tone. If you have CIDCW activated, you will see the number of the caller. The name will appear if Name Tag (POP ID) feature is on.

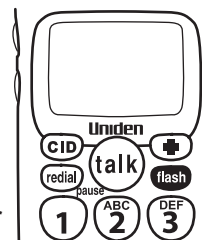

- 2) **Australia:** Press the **flash** key and then 2 to switch between callers.

**New Zealand:** Press the **flash** key to switch between callers.



You must subscribe through your local telephone company to receive Call Waiting service.

## Visual Message Waiting Indicator

If you subscribe to voice mail service, you can use your cordless telephone to access your voice mailbox. The **visual ringer/messages** LED light on the base of your phone flashes whenever you have messages waiting in your voice mailbox. Just dial the access number supplied by your voice mail provider to enter your mailbox. You can program your voice mail access number to a speed dial number.

If the voice mail waiting indicator remains on after you have retrieved your messages, press and hold the **find handset** key for 5 seconds. This will reset the indicator.



You must subscribe to voice mail service from your telephone company in order to use this feature. The voice mail company will provide you with the access number.



## Emergency Dial

Emergency Dial is a one-touch speed dial key. Store your most important or most frequently called number as your Emergency Dial number. Then, simply press the **emergency ( + )** key, and your phone will automatically dial the number.

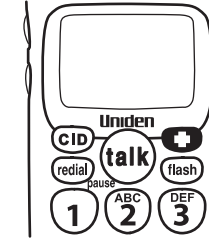

### Storing the Emergency Dial

1) When the phone is in standby mode, press and hold the **emergency ( + )** key. The following display appears.

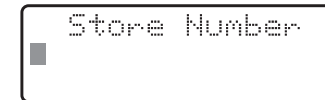

If the Emergency Dial number is already programmed, the Edit screen appears. You can select **Edit Number** to edit this entry, select **Delete Number** to erase this entry or select **Go Back** to return to the previous screen.

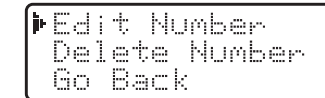

2) Store the number by following step 6 on page 23 under “Storing Names and Numbers in Speed Dial Memory”.

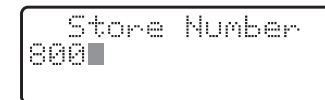

3) Press the **select** key.  
You hear a confirmation tone, and **Number Stored** appears. Memory storage is complete.

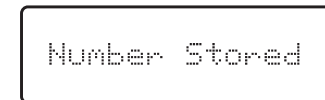



## Using the Speed Dial Memory

The speed dial memory allows you to store up to 10 names and numbers in the handset. You can dial these numbers with just a few key presses.

The speed dial memory is not limited to phone numbers. You can store any number (up to 20 digits) that you need to enter once your call connects. This is referred to as Chain Dialing. For example, you can save your bank account number to speed dial memory. When you call your bank's telephone teller service and are prompted to enter your account number, simply press the **memory** key and the speed dial number where you stored your account number.

### Storing Names and Numbers in Speed Dial Memory

- 1) With the phone in standby mode, press the **memory** key.
- 2) Enter **0 - 9** to select the speed dial number where you would like to store this entry. You can also scroll through the list with the **volume/**  $\Delta$  **/+** and **volume/**  $\Delta$  **/-** keys. Press the **select** key twice.
- 3) **Store Name** appears and a cursor flashes indicating that the display is ready for the name to be entered.

If the selected speed dial number is already assigned, the Edit screen appears. You can select **Edit Memory** to edit this entry, select **Delete Memory** to delete this entry, or select **Go Back** to choose another speed dial number.

```
Select Memory
01
02 JOHN DOE
```

```
01: (Empty)
Press Select
to edit
```

```
Store Name
█
```

```
Edit Memory 01
Delete Memory 01
Go Back
```

[21]



- When editing the speed dial memory, you must press a key within 30 seconds or the phone will return to standby mode. If you return the handset to the base, the phone will return to standby mode also.
- For New Zealand, Telecom access numbers are pre-programmed into speed dial locations as follows;
  - Divert ON: SPD1
  - Divert OFF: SPD2
  - Block CID: SPD3
  - Messages: SPD4
  - Directory: SPD6





If the next character uses the same number key, you must press the **#/→** key to move the cursor over. Otherwise the next time you press the number key, it changes the character that was previously set.

- 4) Enter a name according to the instructions below, then press the **select** key. If no name is required, go to step 5.
- The name can be up to 13 characters.
  - Use the **#/→** and **X /tone/←** keys to move the cursor to the desired location.
  - Use the **delete/channel** key to delete characters as needed.
  - Press and hold the **delete/channel** key to delete all the characters.

Refer to the letters on the number keys to select the desired characters. With each press of a numeric key, the displayed character appears in the following order:

Upper case letters first, lower case letters next and finally the number corresponding to the key.

### **If you make a mistake while entering a name**

Use the **X /tone/←** or **#/→** key to move the cursor to the incorrect character. Press the **delete/channel** key to erase the wrong character. Then enter the correct character. To delete all characters, press and hold the **delete/channel** key.

For example, to enter Movies.

1. Press **6** once. Then press the **#/→** key to move the cursor to the right.
2. Press **6** six times.
3. Press **8** six times.
4. Press **4** six times.
5. Press **3** five times.
6. Press **7** eight times.

Keys	Number of time key is pressed								
	1	2	3	4	5	6	7	8	9
1	1								
2abc	A	B	C	a	b	c	2		
3def	D	E	F	d	e	f	3		
4ghi	G	H	I	g	h	i	4		
5jkl	J	K	L	j	k	l	5		
6mno	M	N	O	m	n	o	6		
7pqrs	P	Q	R	S	P	q	r	s	7
8tuv	T	U	V	t	u	v	8		
9wxyz	W	X	Y	Z	w	x	y	z	9
0oper	*	#	-	&	(	)	(blank)	0	

5) Store Number is displayed. The cursor flashes indicating that the display is ready for the number to be entered.

Store Number  
█

6) Use the keypad to enter the phone number; each number can be up to 20 digits.  
If you need the phone to pause during the dialing sequence, press the **redial/pause** key to insert a two-second delay between the numbers. You can enter multiple pauses to increase the delay. Each pause counts as a digit. The display shows a P for every pause.

Store Number  
8007303456█

**note** When storing numbers into memory, if the handset is idle (i. e., no key is pressed) for more than 30 seconds, it will beep rapidly, and the phone will return to standby mode.



You cannot store a Caller ID message if no phone number appears in the message.

- 7) Press the **select** key. You will hear a confirmation tone, and the following screen appears.

```
Memory 01 Stored
```

Memory storage is complete.  
After about 2 seconds, the following screen displays all the speed dial memory entries.

- 8) Press the **memory** key to exit memory setup mode. The phone returns to standby.

```
01 Movies
02 JOHN DOE
03 MOM AND DAD
```

### Storing Caller ID Messages in Speed Memory Locations

Messages (Caller ID names/numbers) shown in the Caller ID list can be stored in memory dialing. For complete instructions on viewing the Caller ID list, see page 27.

- 1) Press the **CID** key. Select the phone number to be stored from the Caller ID list by pressing the **volume/ Δ /-** or **volume/ Δ /+** key.
- 2) Press the **memory** key.
- 3) Enter a number (**0 - 9**) or press the **volume/ Δ /-** or **volume/ Δ /+** key to select the memory location to be stored.

```
17/05 12:30PM 03
2145551234
```

```
Select Memory
01 Movies
02 JOHN DOE
```





- 4) Press the **select** key. You hear a confirmation tone, and the number is stored in memory. The display returns to the Caller ID list.

**note** If a message has already been stored in the selected memory number location, a confirmation screen is displayed. Press the **volume/ Δ /+** key to select Yes. Press the **select** key to overwrite. The display returns to the Caller ID list.

```
Replace Memory?  
▶ Yes  
No
```

### Making Calls from Speed Dial Memory

- 1) Press the **memory** key. The handset displays your programmed speed dial number.
- 2) Enter the number (**0 - 9**), or press the **volume/ Δ /+** or **volume/ Δ /-** key to select the speed dial number you would like to dial.
- 3) Press the **talk** key. Talk and the number selected appear on the display. Then the displayed number is dialed.

### Easy Dial

Numbers stored in the speed dial memory can be accessed directly from standby mode as follows.

- 1) Press and hold a key from memory location for 1.5 seconds. The details of the memory location will appear on the display.
- 2) Press the **talk** key. The displayed number is dialed.

[25]





- If you answer a call before the Caller ID message is received (for example, before the second ring), the Caller ID message will not appear.
- When the call is received via a telephone company that does not offer Caller ID service, the caller's phone number and name do not appear. (This includes international calls.)
- When the call is via a private branch exchange (PBX), the caller's phone number and name may not appear.

## Caller ID and CIDCW (Caller ID on Call Waiting)

**You must subscribe to Caller ID service through your local telephone provider to use this feature.**

When the telephone rings, the Caller ID feature allows you to view the caller's, phone number, date and time of call, and Name Tag (POP ID) feature allows you to view the caller's name (see pages 12 and 19). The incoming call information is stored in the Caller ID record.

If you subscribe to Caller ID on Call Waiting (CIDCW) you can view a second caller's information first (see Using Call Waiting on page 19 to answer call). The CIDCW service is currently unavailable in New Zealand.

### When the Telephone Rings

1) When the Caller ID message is received, the display shows the caller's phone number along with the date and time. The incoming call information is stored in the Caller ID record.

If Name Tag is on and the caller's number matches an entry in memory then the name will display.

The date and time received	11/05 12:30PM
Caller's name	Jane Smith
Caller's phone number	2145551234

### You may receive any one of the following messages:

When a private number is received; PRIVATE

When an unknown name is received; UNAVAILABLE

When an unknown number is received; UNAVAILABLE

When invalid data is received; INCOMPLETE DATA

When an overseas call(0000) is received (New Zealand only): OVERSEAS CALL

When a call is coming from a payphone (Australia only): PAYPHONE

- 2) When you pick up the phone, the display changes to Talk .  
(Auto Talk feature is set to on.)

**note** Data errors appear as "■".

### Viewing the Caller ID Message List

The Caller ID list stores information for up to 30 incoming calls -even unanswered calls.

- 1) With the phone in standby mode, press the **CID** key.  
The summary screen appears. The screen shows the number of new messages and total messages.

```
Caller ID
New :01
Total:02
```

- 2) To see messages starting with the most recent message, press the **volume/ Δ /-** key. Each time you press the key, you will see the next most recent message.

```
17/05 12:30PM 03
Jane Smith
2145551234
```

- 3) To see messages starting with the oldest message, press the **volume/ Δ /+** key. Each time you press the key, you will see the next oldest message.
- 4) Press the **CID** key to return to standby mode.



- In Caller ID operation, if no key is pressed for more than 30 seconds, an error tone sounds and the telephone returns to standby mode.
- Each message can be up to 15 characters for the phone number and the name.
- The number of calls from the same Caller ID appears next to the received time. Once you view the new message, the number will be cleared and disappear.



- While using the Delete All? or Delete Message? screen, if no key is pressed for more than 30 seconds, an error tone sounds, and the handset returns to standby mode.
- If you get an incoming call or page, the deleting operation is canceled, and you can answer the call or page.

### Deleting Information from the Caller ID List

The cordless phone stores up to 30 messages (Caller ID names/numbers). If the phone receives the 31st message, the oldest one in the list is automatically deleted. Caller ID data can also be deleted manually.

#### Deleting a Caller ID message

- 1) Press the **CID** key in standby mode. Find the message to be deleted from the Caller ID list by pressing the **volume/ Δ /+** or **volume/ Δ /-** key.
- 2) Press the **delete/channel** key. Press the **volume/ Δ /+** or **volume/ Δ /-** key to select Yes or No.
- 3) Press the **select** key.

```
17/05 12:30PM 03  
Jane Smith  
2145551234
```

```
Delete Message?  
▶ Yes  
No
```



### Deleting all Caller ID names/numbers

- 1) With the phone in standby mode, press the **CID** key.
- 2) Press the **delete/channel** key.
- 3) Press the **volume/ Δ /+** key to select Yes , and then press the **select** key.

You hear a confirmation tone and all stored Caller ID messages are deleted.

```
Caller ID  
New :01  
Total:02
```

```
Caller ID  
Total:00
```





You cannot make a call from the Caller ID list if your cordless phone is connected to a private branch exchange (PBX).

### Making a Call from the Caller ID List

You can place a call from the Caller ID list.

- 1) Press the **CID** key. Select the phone number that you want to dial by pressing the **volume/ Δ /+** or **volume/ Δ /-** key.
- 2) Press the **talk** key. The displayed phone number dials automatically.

```
17/05 12:30PM 03  
Jane Smith  
2145551234
```

```
Talk  
2145551234
```



## Changing the Digital Security Code

To protect you against misbilled calls which might result from your phone being activated by other equipment, the cordless phone provides AutoSecure (which electronically locks your phone when the handset is in the base) and Random Code digital security (which automatically selects one of over 262,000 digital security codes for the handset and base).

If the handset battery pack is completely discharged or the battery pack is removed, the digital security code will be lost. If this happens, a new security code is set automatically the next time the battery pack is charged.

The digital security code is an identification code used to connect the handset and the base unit. Normally, setting the code is not necessary. The first time you charge your handset, the security code is automatically set.

In the rare situation that you suspect another cordless telephone is using the same security code, you can change the code.

- 1) Remove the handset from the base unit. Press and hold the ***find handset*** key on the base.
- 2) While holding the ***find handset*** key, place the handset in the base unit, and leave the handset on the base for more than 3 seconds. A new random security code is set.





## Note on Power Sources



### Low battery alert

When the battery pack is very low and needs to be charged, the phone is programmed to eliminate functions in order to save power. If the phone is not in use, Low Battery appears on the LCD and none of the keys will operate.

If the phone is in use, Low Battery flashes and the handset beeps. Complete your conversation as quickly as possible and return the handset to the base unit for charging.



Information stored in the phone's memory will be retained for 30 minutes after the battery pack is removed.

This includes all setup information, last number dialed, speed dial memory, Emergency Dial programming, and the CID list.

Even when the battery pack is not being used, it will gradually discharge over a long period of time. For optimum performance, be sure to return the handset to the base unit after a telephone call.

### Battery replacement and handling

When the operating time becomes short even after a battery is recharged, please replace the battery. With normal usage, your battery should last about one year. Please contact your place of purchase or visit our website for more information. [www.uniden.com.au](http://www.uniden.com.au) or [www.uniden.co.nz](http://www.uniden.co.nz)

**Warning:** To avoid the risk of personal injury or property damage from fire or electrical shock, only use the Uniden battery model and Uniden adapter model specifically designated for this product.

#### Power Failure

During the period that the power is off, you will not be able to make or receive calls with the telephone.

#### Caution

- Use only the specified Uniden battery pack (BT-905).
- Do not remove the battery from the handset to charge it.
- Never throw the battery into a fire, disassemble it, or heat it.
- Do not remove or damage the battery casing.



### Installing a Replacement Battery

Follow the steps below if you need to replace a battery.

- 1) Press down on the handset battery case cover (use the finger indentation for a better grip) and slide the cover downward to remove.
- 2) Remove the existing battery and unplug the connector from the jack.
- 3) Plug the battery pack connector (red & black wires) into the jack inside the battery compartment. (The connector notches fit into the grooves of the jack only one way.) Match the wire colors to the polarity label in the battery compartment, connect the battery, and listen for a click to insure connection.
- 4) Make sure you have a good connection by slightly pulling on the battery wires. If the connection is secure, the battery jack will remain in place.
- 5) Place the battery case cover back on the handset by sliding it upwards until it clicks into place.

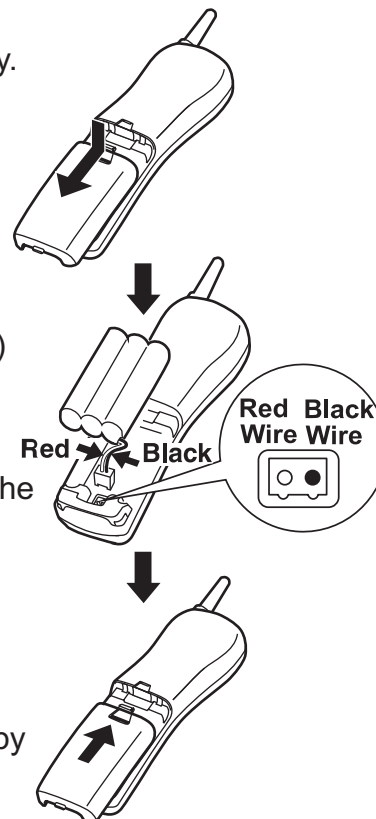

Use only the Uniden rechargeable battery pack (BT-905) supplied with your cordless telephone.

ADDITIONAL INFORMATION





## Maintenance

To maintain a good charge, it is important to clean the charging contacts on both the handset and base once a month. Using water only, dampen a cloth to clean the charging contacts. Then, make sure to go back over the charging contacts with a dry cloth.

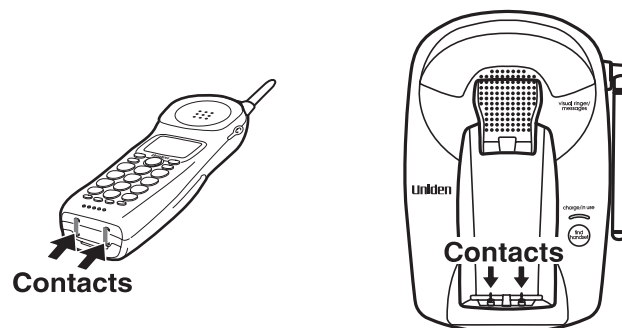

### Caution

Do not use paint thinner, benzene, alcohol, or other chemical products. Doing so may discolor the surface of the telephone and damage the finish.





## Troubleshooting

If your phone is not performing to your expectations, please try these simple steps first. If these steps do not solve your problem, visit our website for further information ([www.uniden.com.au](http://www.uniden.com.au) or [www.uniden.co.nz](http://www.uniden.co.nz)).

Symptom	Suggestion
The <b>charge/ in use</b> LED won't illuminate when the handset is placed in the cradle.	<ul style="list-style-type: none"><li>• Make sure the AC adapter is plugged into the cradle and wall outlet.</li><li>• Make sure the handset is properly seated in the cradle.</li><li>• Make sure the charging contacts on the handsets are clean.</li></ul>
The audio sounds weak and/ or scratchy.	<ul style="list-style-type: none"><li>• Move the handset and/ or main base away from metal objects or appliances and try again.</li><li>• Press the <b>delete/channel</b> key to help eliminate background noise.</li><li>• Make sure that the handset is not too far from the main base.</li></ul>
Can't make or receive calls.	<ul style="list-style-type: none"><li>• Check both ends of the telephone line cord.</li><li>• Make sure the AC adapter is plugged into the main base and wall outlet.</li><li>• Disconnect the AC adapter for a few minutes. Then reconnect it.</li><li>• Change the digital security code (see page 31).</li><li>• Make sure that the handset is not too far from the main base.</li><li>• Check the dialing mode used by your telephone company.</li></ul>



<b>Symptom</b>	<b>Suggestion</b>
The handset doesn't ring or receive a page.	<ul style="list-style-type: none"> <li>• The battery pack may be weak. Charge the battery for 15- 20 hours.</li> <li>• The handset may be too far from the main base.</li> <li>• Place the main base away from appliances or metal objects.</li> <li>• Change the digital security code (see page 31).</li> <li>• Check the battery pack to ensure there is a secure connection.</li> <li>• Make sure ringer volume isn't set to "off."</li> </ul>
Severe noise interference.	<ul style="list-style-type: none"> <li>• Keep the handset away from microwave ovens, computers, remote control toys, wireless microphones, alarm systems, intercoms, room monitors, fluorescent lights, and electrical appliances.</li> <li>• Move to another location or turn off the source of interference.</li> </ul>
The Caller ID does not display.	<ul style="list-style-type: none"> <li>• The call was answered before the second ring.</li> <li>• The call was placed through a switchboard.</li> <li>• Charge the handset.</li> <li>• Your Caller ID service may not be active; contact your local telephone service provider.</li> </ul>
Visual Message Waiting Indication does not work.	<ul style="list-style-type: none"> <li>• Reset the indicator by pressing and holding the <b>find handset</b> key for 5 seconds.</li> <li>• Contact your local telephone company to make sure that your telephone receives FSK message signaling.</li> </ul>



## Liquid Damage

Moisture and liquid can damage your cordless phone. In case of accidental submersion, please read the following steps.

Case	Action
If the handset or base is exposed to moisture or liquid, but it only affects the exterior plastic housing.	Wipe off the liquid, and use as normal.
If moisture or liquid has entered the plastic- housing (i. e. liquid can be heard in the phone or liquid has entered the handset battery compartment or vent openings on the base).	<p><b>Handset:</b></p> <ol style="list-style-type: none"> <li>1) Remove the battery cover and leave it off for ventilation.</li> <li>2) Remove the battery pack by disconnecting.</li> <li>3) Leave the battery cover off and the battery pack disconnected for at least 3 days.</li> <li>4) Once the handset is completely dry, reconnect the battery pack and the battery cover.</li> <li>5) Recharge the handset's battery pack for 20 hours before using again.</li> </ol> <p><b>Base:</b></p> <ol style="list-style-type: none"> <li>1) Disconnect the AC adaptor from the base unit, cutting off electrical power.</li> <li>2) Disconnect the telephone cord from the base unit.</li> <li>3) Let dry for at least 3 days.</li> </ol> <p><b>IMPORTANT:</b> You must unplug the telephone line while recharging the battery pack to avoid charge interruption.</p> <p><b>CAUTION:</b> DO NOT use a microwave oven to speed up the drying process. This will cause permanent damage to the handset, base and the microwave oven. After following these steps, if your cordless telephone does not work, please visit our website for further information (<a href="http://www.uniden.com.au">www.uniden.com.au</a> or <a href="http://www.uniden.co.nz">www.uniden.co.nz</a>).</p>





## General Information

Operating temperature: -10° to +50°C (+14°F to +122°F)

### AC Adapter Information

AC Adapter part number: AAD--041S  
Input Voltage: 230-240V AC 50Hz  
Output Voltage: 9V DC 350 mA

### Battery Information

Battery part number: BT-905  
Capacity: 600 mAh, 3.6V



- **To avoid damage to the phone use only Uniden AAD--041S and BT-905 with your phone.**
- If the handset is left off of the base, the actual Talk mode duration will be reduced respective to the amount of time the handset is off the base.

Recharge your phone on a regular basis by returning the handset to the base after each phone call. When the operating time becomes short, even after the battery is recharged, please replace the battery. With normal usage, the battery should last about one year.

A replacement Uniden adapter and battery may be purchased at your local Uniden dealer or by visiting our website at; [www.uniden.com.au](http://www.uniden.com.au) or [www.uniden.co.nz](http://www.uniden.co.nz)  
Specifications, features, and availability of optional accessories are all subject to change without prior notice.



# Index

## A

AC adapter information	38
Audio boost	16

## B

Basic setup	11
Battery pack	
Replacement and handling	32
Beltclip installation	10

## C

Call waiting	19
Caller ID service	26
Caller ID on Call	
Waiting	19, 26
Deleting	28
Making a call	30
Viewing	27
Channel	18
Charging a battery back	6
Cleaning contacts	34
Connect the base unit	6
Controls and Functions	3

## D

Digital security code	31
-----------------------	----

## E, F, G

Earpiece volume	16
Emergency dial	20
Find Handset	18
General information	38

## H

Headset installation	10
----------------------	----

## I, J, K, L

Liquid Damage	37
---------------	----

## M, N, O, P, Q

Maintenance	34
Making a call	15

## R

Receiving a call	15
Redial	16
Ringer tone	14

## S

Speed dial memory	
Making calls from speed dial memory	25
Storing names and numbers in speed dial memory	21

## T, U

Traveling out-of-range	17
Troubleshooting	35

## V, W, X, Y, Z

Voice mail waiting indicator	19
Wall mounting	9
Warranty	40



# One Year Limited Warranty

**Important:** Evidence of original purchase is required for warranty service.

**Warrantor:** Uniden Australia Pty Limited A.B.N. 58 001 865 498 Uniden New Zealand Limited  
**Warranty is only valid in the original country of purchase.**

**ELEMENT OF WARRANTY:** Uniden warrants to the original retail owner for the duration of this warranty, its SS E15 (herein after referred to as the Product), to be free from defects in materials and craftsmanship with only the limitations or exclusions set out below.

**WARRANTY DURATION:** This warranty to the original retail owner only, shall terminate and be of no further effect 12 months after the date of original retail sale. This warranty will be deemed invalid if the product is;

- (A) Damaged or not maintained as reasonable and necessary,
- (B) Modified, altered or used as part of any conversion kits, subassemblies, or any configurations not sold by Uniden,
- (C) Improperly installed,
- (D) Repaired by someone other than an authorized Uniden Repair Agent for a defect or malfunction covered by this warranty,
- (E) Used in conjunction with any equipment or parts or as part of a system not manufactured by Uniden.

**PARTS COVERED:** This warranty covers for one (1) year, the Base unit and handset ( SS E15). All accessories (AC adaptor etc)are covered for 90 days only.

**STATEMENT OF REMEDY:** In the event that the product does not conform to this warranty at any time while this warranty is in effect, the warrantor at its discretion, will repair the defect or replace the product and return it to you without charge for parts or service.

THIS WARRANTY DOES NOT COVER OR PROVIDE FOR THE REIMBURSEMENT OR PAYMENT OF INCIDENTAL OR CONSEQUENTIAL DAMAGES. THIS GUARANTEE IS IN ADDITION TO AND DOES NOT IN ANY WAY AFFECT YOUR RIGHTS UNDER THE CONSUMER GUARANTEE ACT.

**PROCEDURE FOR OBTAINING PERFORMANCE OR WARRANTY:** In the event that the product does not conform to this warranty, the Product should be shipped or delivered, freight pre-paid, with evidence of original purchase (e.g. a copy of the sales docket), to the warrantor at:

**UNIDEN AUSTRALIA PTY LIMITED  
SERVICE DIVISION**

345 Princes Highway,  
Rockdale,  
NSW 2216,  
AUSTRALIA  
Fax: (02) 9599 3278  
[www.uniden.com.au](http://www.uniden.com.au)

**UNIDEN NEW ZEALAND LIMITED  
SERVICE DIVISION**

150 Harris Road,  
East Tamaki,  
Auckland,  
NEW ZEALAND  
Fax: (09) 274 4253  
[www.uniden.co.nz](http://www.uniden.co.nz)



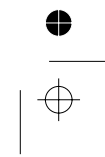
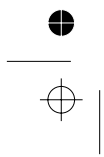
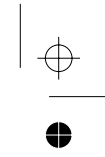
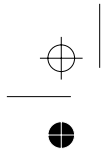

**THANK YOU FOR BUYING A UNIDEN PRODUCT.**

**Uniden<sup>®</sup>**

© 2005 Uniden Australia Pty Limited. Uniden New Zealand Ltd. Printed in China UPZZ01067ZZ(0)